

SEWING MACHINE TABLE

COMFORT 9

СТОЛ ДЛЯ ШВЕЙНОЙ МАШИНЫ

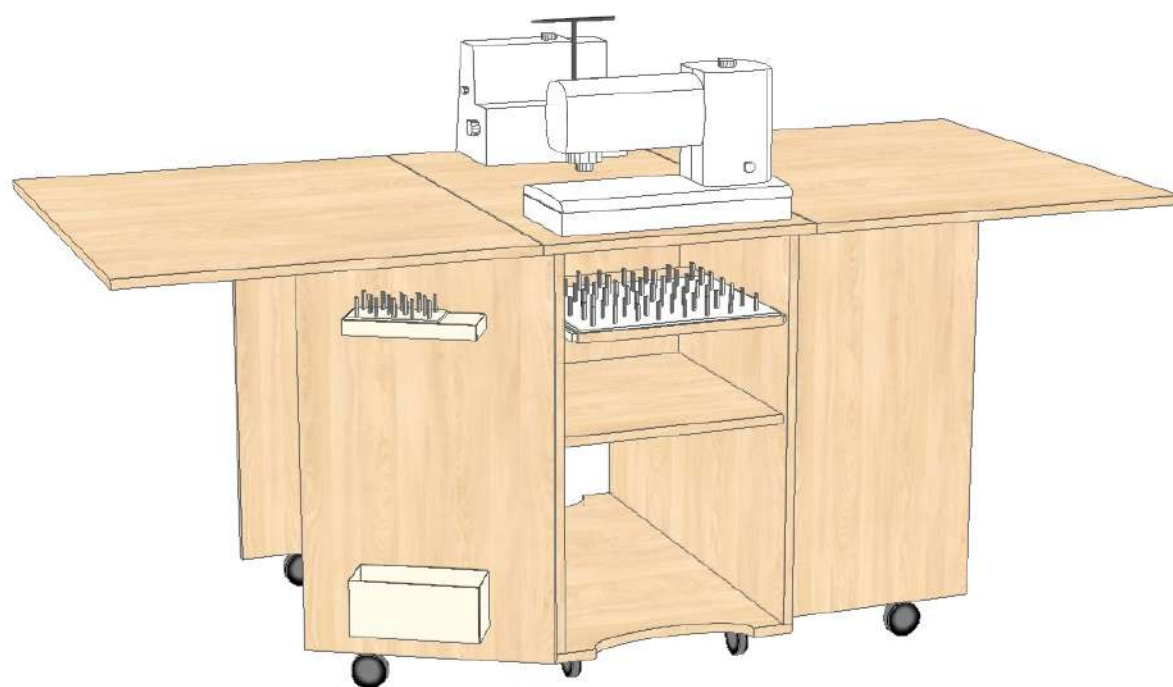

SYMBOLS



ATTENTION

ВНИМАНИЕ



ASSEMBLY & ADJUSTMENT

СБОРКА РЕГУЛИРОВКА



OPERATION

ЭКСПЛУАТАЦИЯ

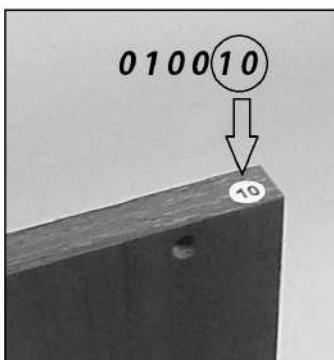

INDICATING MARK

ОБОЗНАЧЕНИЕ

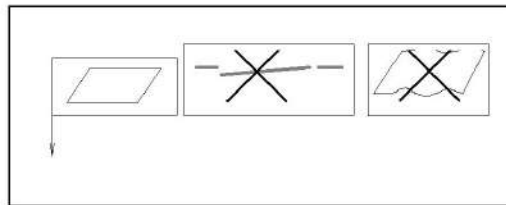







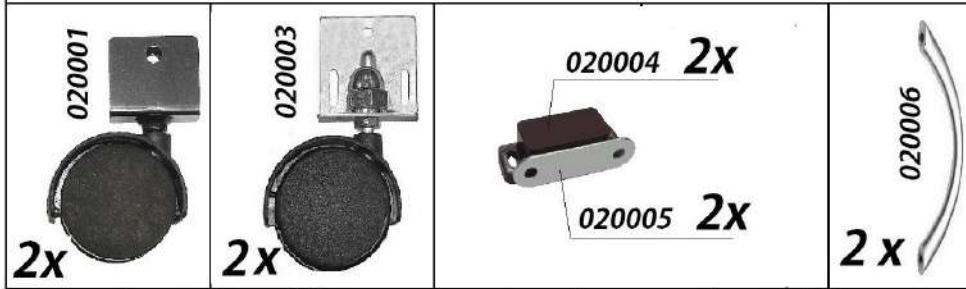





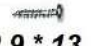





EVEN SURFACE

РОВНАЯ ПОВЕРХНОСТЬ

010001 1x	010002 2x	010004 1x	010006 1x
010007 1x	010011 2x	010012 2x	010013 2x
010015 1x	010020 2x	010026 1x	010028 1x
010030 1x	010033 1x	010034 1x	



 030001 3 * 16 16x	 030002 3,5 * 16 36x	 030003 6,2 * 50 14x	 030004 φ5 * 16 2x	 030033 4,2 * 13 50x	 030006 2,9 * 13 8x	
 030008 φ4 4x	 030009 M4 * 20 4x	 030011 φ15 14x	 030012 φ18 6x	 030013 L = 35 6x	 030014 φ15 h12 6x	 030028 3,9*16 8x
 030015 φ8 * 30 8x	 030016 φ8 * 30 4x	 030017 φ15 h10 4x	 030022 M 10 4x	 030023 φ 10 4x	 030031 φ 10 s2,5 4x	





S 4 *

S 5

S 10
S 12



2 8x 030011
8x 03003

1 030002
6x
020013 CR 3x

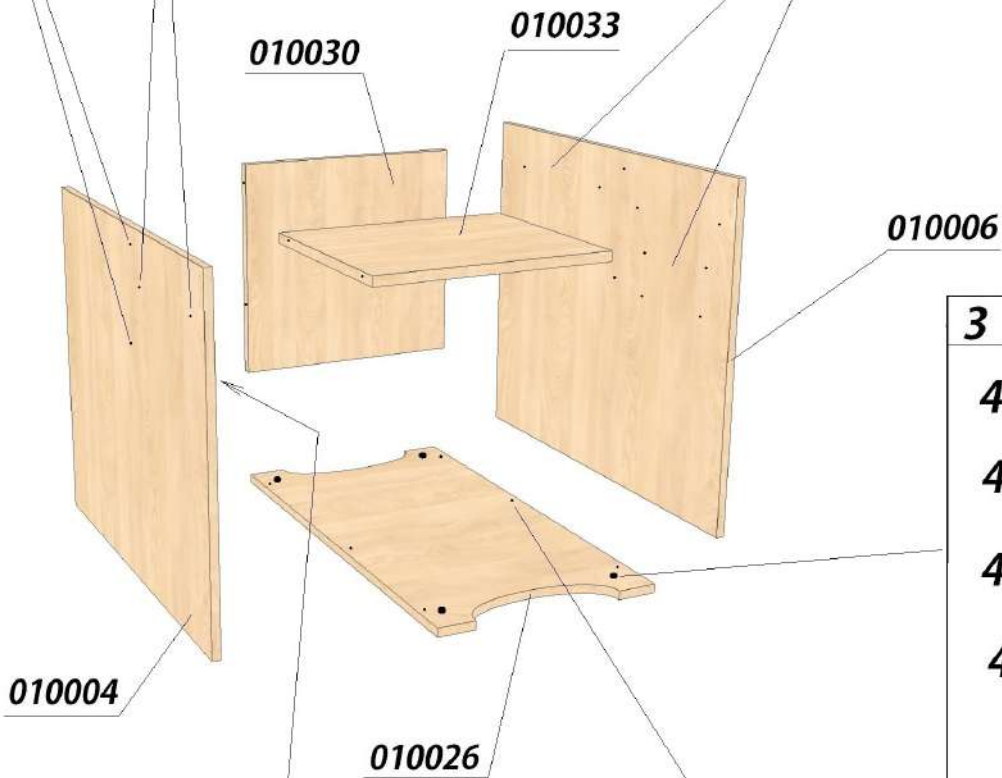



3 4x 030022
4x 030031
4x 030023
4x 020034



1 020013 CL 3x
030002 6x

4 6x 030011
6x 030003

4

*
Входит в комплект стола.
Included into table set.

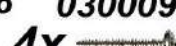
6 020011
 2x 
 8x  030002

5 030008 030009
 4x  4x 
 2x  020006

7 020003
 2x 
 6x  030033

15 17 18

010007
 010015

8 4x  030006
 2x  020004

010001

9 030015
 4x 



10 030013
 6x 

010015

11 6x  030014
 6x  030012

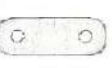

010007

14 020005
 2x 
 4x 030001 

12 8x  030028
 12x  030002

 4x 020018

13 020012 030006
 2x  4x 

17 24x 030033

 6x 020019



16 16x 030033

 4x 020019



15 020001 030004
 2x  2x 

2x 010002

21

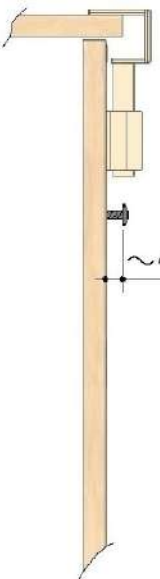
 1x 010034

20 4x 020020



 ~4MM

18 030033
 2x 
 1x 050001

19

 1x 050003

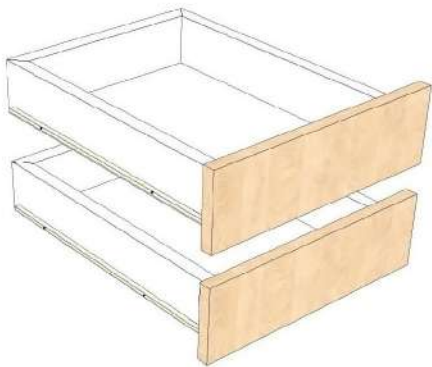
 1x 050002 2x 030033

22

4x 030001

2x 020015 DR

030016 **24**

4x

25

4x 030017

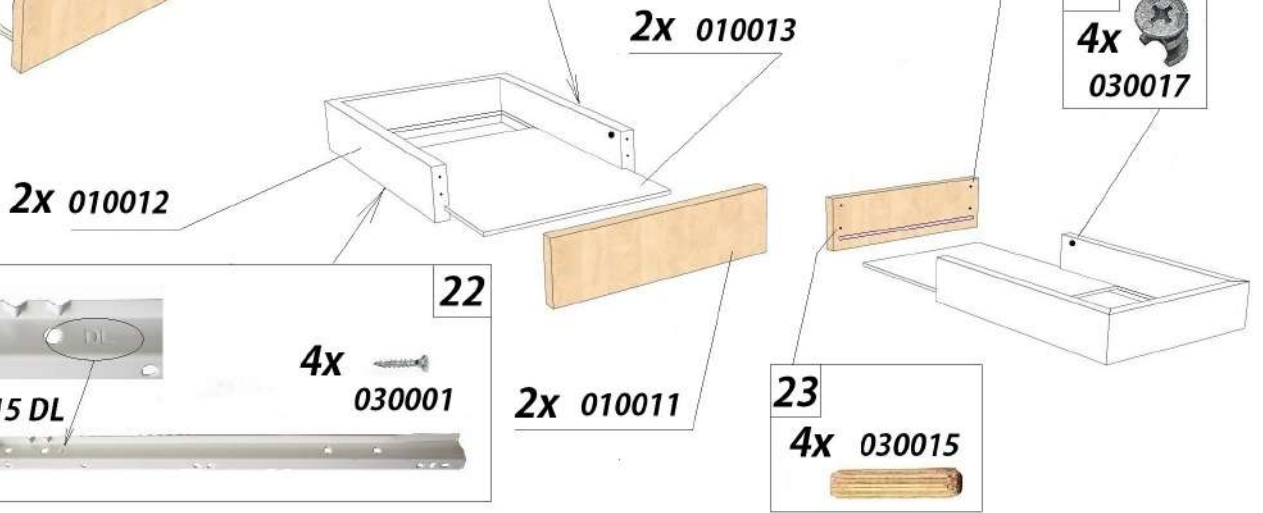

22

4x 030001

2x 020015 DL

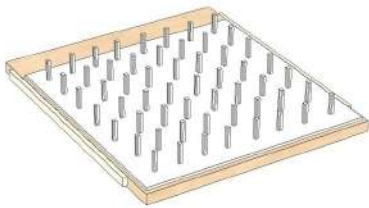

26

1x 020015 DL

2x 030001

27

4x 030002

1x 050004

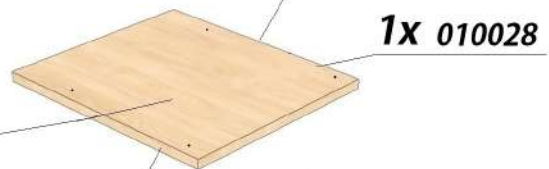

26

2x 030001

1x 020015 DR

